

PB-24-100-PRO

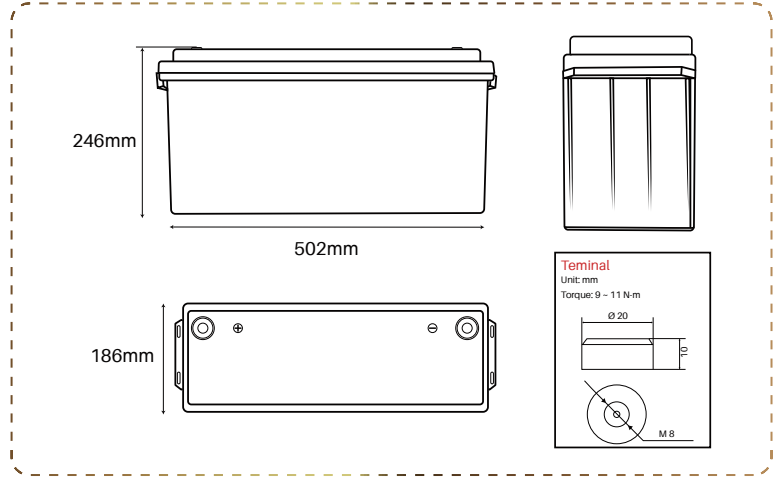

LITHIUM BATTERY

Strong Advantages

- 6 Years Warranty
- Replacement of lead-acid battery
- Lighter weight and easier to handle
- Lithium iron phosphate is more stable
- Maximum service life of over 6000 cycles
- Long-lasting modular construction
- Screw opening, perfect crafted internal structure design

BMS

Battery Management System

The BMS monitors and controls the individual cells of a battery and protects them from damage, such as overload and overvoltage

BLUETOOTH 4.0 INTEGRATED

Multiple Battery Monitoring Function

Perfektium Pro APP can monitor up to 8 batteries at the same time. The SOC, voltage, current, temperature, available time of the batteries can be detective.



Specification

Items	Characteristics
Model	25.6V 100Ah/2560Wh
Replaces Gel-AGM battery	25.6V 200Ah
Cell type	Prismatic cell
Dimension with terminals (L x W x H)	502*186*243mm
Weight (No Accessories)	20.85Kg
Cycle Life	>6000@80%D.o.D
Internal Resistance	≤15 mΩ @ 50% SOC
Recommended Charge Voltage	29.2V
Float Charge Voltage (For standby use)	27.6±0.8V
Recommended Charge Current	30A
Max Charge Current	50A
Continuous Discharge Current	100A
Peak Discharge Cut-Off Current	300A (200~500ms)
Operating Voltage Range	20 - 29.2V
End of Discharge Voltage Range	18.4 - 22.4V
Terminal Type	M8
Ingress Protection Code	IP65
Charge Temperature	0~50°C
Discharge Temperature	-20~75°C
Storage Temperature	-5~35°C
Storage Condition	Charging the battery every 3 months
Series & Parallel Availability	Maximum 2 pcs in series and 4 pcs in parallel
Certifications	CE/UL/UN38.3 /MSDS /ROHS/UN 3480/ CLASS9/ECE R10